



KITCHEN SINKS DESIGNED FOR TODAY'S KITCHENS



 **COMPASS[®]**
MANUFACTURING
INTERNATIONAL

Belleville

R15 Radius Corner Under-Mount Apron Front Farm Sinks



33"x21"x10"

Flat Front

Model 482-6805

10" Apron Height
10" Deep 60/40 Double Bowl
16 Gauge



33"x21"x10"

Curved Front

Model 482-0254

10" Apron Height
10" Deep 60/40 Double Bowl
16 Gauge



33"x21"x10"

Flat Front

Model 481-6889

10" Apron Height
10" Deep Single Bowl
16 Gauge



33"x21"x10"

Curved Front

Model 482-6807

10" Apron Height
10" Deep Single Bowl
16 Gauge



33"x21"x10"

Flat Front

Model 482-6806

10" Apron Height
10" Deep 50/50 Double Bowl
16 Gauge



33"x21"x10"

Curved Front

Model 482-6808

10" Apron Height
10" Deep 50/50 Double Bowl
16 Gauge

Includes: Corrosion Resistant Grid(s). Not Included: Faucet or Basket Strainer(s).

Parketon

R15 Radius Corner Under-Mount Apron Front Farm Sinks



30"x21"x10"
Curved Front

Model 482-6809

10" Apron Height

10" Deep 60/40 Double Bowl

16 Gauge



30"x21"x10"
Curved Front

Model 482-6810

10" Apron Height

10" Deep 50/50 Bowl

16 Gauge



30"x21"x10"
Curved Front

Model 482-0255

10" Apron Height

10" Deep Single Bowl

16 Gauge

Includes: Corrosion Resistant Grid(s). Not Included: Faucet or Basket Strainer(s).

www.cmiproduct.com



 COMPASS[®]
MANUFACTURING
INTERNATIONAL

Lapeer®

R15 Radius Corner Under-Mount Apron Front Farm Sinks



31"x20"x7-3/4"

Flat Front

Model 482-6811

8-3/8" Apron Height

7-3/4" Deep 60/40 Double Bowl

18 Gauge



31"x20"x7-3/4"

Flat Front

Model 482-6767

8-3/8" Apron Height

7-3/4" Deep Single Bowl

18 Gauge



31"x20"x7-3/4"

Flat Front

Model 482-6812

8-3/8" Apron Height

7-3/4" Deep 50/50 Double Bowl

18 Gauge

Includes: Corrosion Resistant Grid(s). Not Included: Faucet or Basket Strainer(s).

www.cmiproduct.com

Asheboro

R15 Radius Corner Under-Mount Apron Front Farm Sinks



36"x22"x10"
Curved Front
Model 482-6512
10" Apron Height
10" Deep 60/40 Double Bowl
16 Gauge



36"x22"x10"
Curved Front
Model 482-6513
10" Apron Height
10" Deep Single Bowl
16 Gauge



36"x22"x10"
Curved Front
Model 482-6514
10" Apron Height
10" Deep 50/50 Double Bowl
16 Gauge



Includes: Corrosion Resistant Grid(s). Not Included: Faucet or Basket Strainer(s).



 **COMPASS[®]**
MANUFACTURING
INTERNATIONAL

Brimley

Retrofit Dual-Mount Apron Front Farm Sinks



33"x24"x8"

Flat Front

Model 482-6933

7-1/2" Apron Height

8" Deep 60/40 Double Bowl

18 Gauge



33"x25"x8"

Curved Front

Model 482-6936

8" Apron Height

8" Deep 60/40 Double Bowl

18 Gauge



33"x24"x8"

Flat Front

Model 482-6934

7-1/2" Apron Height

8" Deep Single Bowl

18 Gauge



33"x25"x8"

Curved Front

Model 482-6937

8" Apron Height

8" Deep Single Bowl

18 Gauge



33"x24"x8"

Flat Front

Model 482-6935

7-1/2" Apron Height

8" Deep 50/50 Double Bowl

18 Gauge



33"x25"x8"

Curved Front

Model 482-6938

8" Apron Height

8" Deep 50/50 Double Bowl

18 Gauge

Includes: Corrosion Resistant Grid(s). Not Included: Faucet or Basket Strainer(s).

This series can be purchased with 1, 2, 3 or 4 hole faucet configurations. Ask your sales representative for more information!

www.cmiproduct.com



 COMPASS[®]
MANUFACTURING
INTERNATIONAL

Brimley

Retrofit Dual-Mount Black Stainless Steel Apron Front Farm Sinks



33"x24"x8"
Flat Front
Model 482-8023
7-1/2" Apron Height
8" Deep 60/40 Double Bowl
18 Gauge

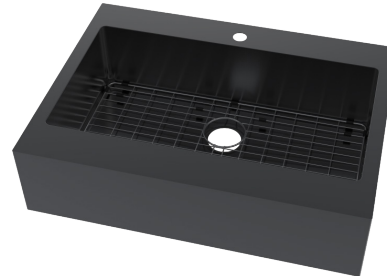

33"x24"x8"
Flat Front
Model 482-8024
7-1/2" Apron Height
8" Deep Single Bowl
18 Gauge



33"x24"x8"
Flat Front
Model 482-8025
7-1/2" Apron Height
8" Deep 50/50 Bowl
18 Gauge

Includes: Corrosion Resistant Grid(s). Not Included: Faucet or Basket Strainer(s).

This series can be purchased with 1, 2, 3 or 4 hole faucet configurations. Ask your sales representative for more information!

www.cmiproduct.com



 COMPASS[®]
MANUFACTURING
INTERNATIONAL

Blanchard

Retrofit Work Station Dual Mount Apron Front Farm Sinks



33"x24"x8"
**Flat Front
Work Station**
Model 482-7213
7-1/2" Apron Height
8" Deep Single Bowl
18 Gauge



33"x24"x8"
**Flat Front
Work Station**
Model 482-7216
7-1/2" Apron Height
8" Deep 60/40 Double Bowl
18 Gauge



33"x24"x8"
**Flat Front
Work Station**
Model 482-7219
7-1/2" Apron Height
8" Deep 50/50 Double Bowl
18 Gauge



33"x25"x8"
**Curved Front
Work Station**
Model 482-7222
8" Apron Height
8" Deep Single Bowl
18 Gauge



33"x25"x8"
**Curved Front
Work Station**
Model 482-7225
8" Apron Height
8" Deep 60/40 Double Bowl
18 Gauge



33"x25"x8"
**Curved Front
Work Station**
Model 482-7228
8" Apron Height
8" Deep 50/50 Double Bowl
18 Gauge

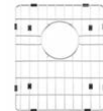
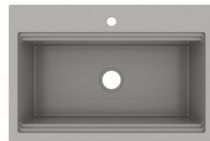

Includes: Corrosion Resistant Grid(s), Wood Cutting Board, Stainless Steel Colander & Drying Rack. Not Included: Faucet or Basket Strainer(s).

This series can be purchased with 1, 2, 3 or 4 hole faucet configurations. Ask your sales representative for more information!



 COMPASS[®]
MANUFACTURING
INTERNATIONAL

Retrofit Apron Front Farm Sinks Checklist

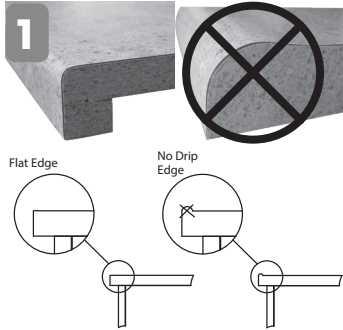

1 Is your countertop flat?

The counter top must be flat to ensure a proper installation.

Please Note – Countertops with a “no drip” edge will not work with this sink application.

YES NO

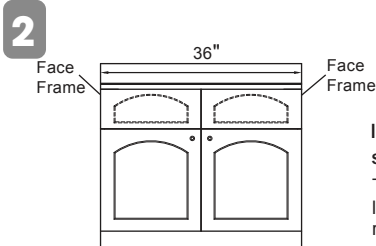

2 Is your sink base cabinet 36” wide?

Measure the face frame from the left to the right on your sink base to determine the width.

YES NO

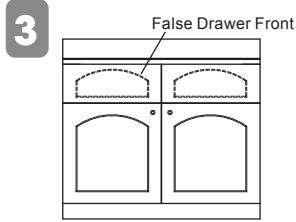

3 Does your cabinet have false drawer fronts?

(Can be one or two false drawer fronts)

YES NO

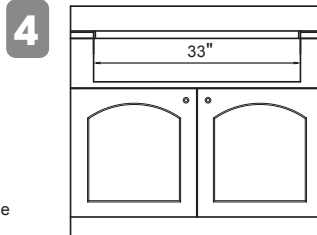

4 Is the dimension between the cabinet stiles 33”?

This measurement is the open space from left to right when the false drawer front is removed.

Typically, this distance can be measured from the inside of the cabinet without removing the false drawer fronts.

YES NO

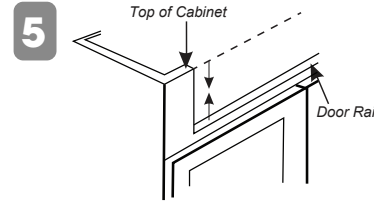

5 Measure the distance from the top of the door rail to the top of the cabinet.

Add 1-1/2” to the measurement to account for the countertop height.

The total will tell you which sink to choose.

Typically, this distance can be measured from the inside of the cabinet.

Measurement

Measurement + 1-1/2”

Total

Total

7-1/2” = Flat Apron Front

8” = Curved Apron Front

Please Note – 7-1/2” Flat Apron Front Sink can be used for an 8” opening by furring out the 1/2” gap (furring not included)

6 If you have answered yes to all of the questions you can choose one of the Retrofit Apron Front Farm Sinks listed on the website for your kitchen.

Before:



After:



Installation Video Online

www.cmiproduct.com

<https://www.youtube.com/watch?v=uB8UFQMfE3Q>

Drexmore™

Work Station Stainless Steel Waterfall Faucet Sink Kit



33"x22"x9"
**Drexmore Work Station
Waterfall Sink Kit**
Model 482-8090
9" Deep
Large Single Bowl
18 Gauge

Includes: Stainless Steel Sink, Waterfall Pull-Down Faucet, Custom Fruit and Vegetable Rinsing Basket, Drying Rack, Corrosion Resistant Sink Grid, Basket Strainer and Glass Rinsers



33"x22"x9"
**Drexmore Work
Station Sink**
Model 482-7845
9" Deep
Large Single Bowl
18 Gauge

Includes: Stainless Steel Sink, Custom Fruit and Vegetable Rinsing Basket, Drying Rack and Corrosion Resistant Sink Grid

Includes: Corrosion Resistant Grid(s).

www.cmiproduct.com

Vandermere

R15 Radius Corner Dual-Mount Sinks

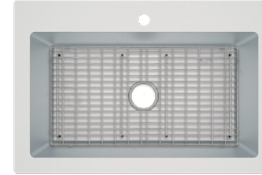

33"x22"x9"

Model 482-7023

9" Deep Large Single Bowl
18 Gauge



33"x22"x9"

Model 482-7024

9" Deep 50/50 Double Bowl
18 Gauge

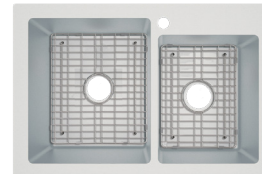

33"x22"x9" & 7-1/2"

Model 482-7025

9" & 7-1/2" Deep 60/40 Double
Bowl
18 Gauge

Includes: Corrosion Resistant Grid(S). Not Included: Faucet or Basket Strainer(s).

This series can be purchased with 1, 2, 3 or 4 hole faucet configurations. Ask your sales representative for more information!

www.cmiproduct.com

Vandermere

R15 Radius Corner Dual-Mount Black Stainless Steel Sinks

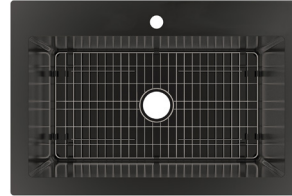

33"x22"x9"

Model 482-8060

9" Deep Large Single Bowl
18 Gauge

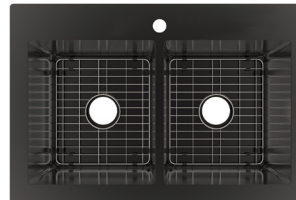

33"x22"x9"

Model 482-7779

9" Deep 50/50 Double Bowl
18 Gauge

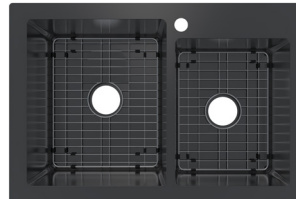

33"x22"x9 & 7-1/2"

Model 482-7783

9" Deep 60/40 Double Bowl
18 Gauge

Includes: Corrosion Resistant Grid(S). Not Included: Faucet or Basket Strainer(s).

This series can be purchased with 1, 2, 3 or 4 hole faucet configurations. Ask your sales representative for more information!

www.cmiproduct.com

Vandermere

Single Bowl Dual-Mount Sinks



20"x20"x10"
Dual-Mount Sink
Model 482-7771
10" Deep Single Bowl
18 Gauge

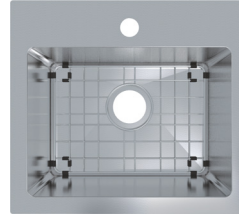

19"x17"x8"
Vandermere Sink
Model 482-7772
8" Deep Single Bowl
18 Gauge

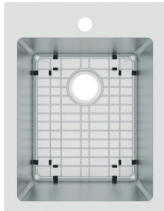

17"x22"x9"
Vandermere Sink
Model 482-7774
9" Deep Single Bowl
18 Gauge

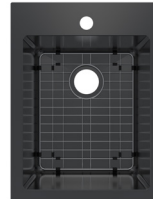

17"x22"x9"
Vandermere Black Stainless Steel Sink
Model 482-7707
9" Deep Single Bowl
18 Gauge

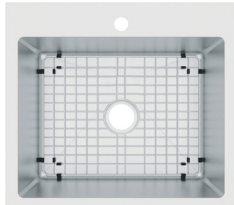

25"x22"x9"
Vandermere Sink
Model 482-7776
9" Deep Single Bowl
18 Gauge

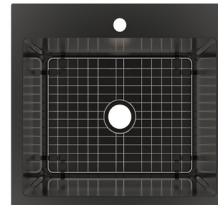

25"x22"x9"
Vandermere Black Stainless Steel Sink
Model 482-7777
9" Deep Single Bowl
18 Gauge

Includes: Corrosion Resistant Grid(S). Not Included: Faucet or Basket Strainer(s).

This series can be purchased with 1, 2, 3 or 4 hole faucet configurations. Ask your sales representative for more information!

R15 Radius Under-Mount Sinks

33"x19"x10"

Model 482-0253

10" Deep Large Single Bowl

18 Gauge

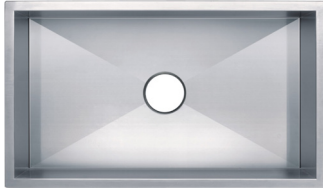

Double Bowl Under-Mount Sinks

31-1/2"x20-1/2"x9" & 7-1/2"

Sleeved Model 481-0582

Individually Boxed 712-6318

9" & 7-1/2" Deep 60/40 Double Bowl

18 Gauge



31-1/2"x20-1/2"x7-1/2" & 9"

Sleeved Model 481-0608

Individually Boxed 712-6319

7-1/2" & 9" Deep 60/40 Double Bowl

18 Gauge



31-1/8"x18"x9"

Sleeved Model 481-0590

Individually Boxed 712-6317

9" Deep 50/50 Double Bowl

18 Gauge



Single Bowl Under-Mount Sinks

16"x16"x8"

Sleeved Model 481-0605

Individually Boxed 712-6313

8" Deep Single Bowl

18 Gauge



23-1/4"x21"x9"

Sleeved Model 481-0588

Individually Boxed 712-6315

9" Deep Single Bowl

18 Gauge



23-3/8"x17-3/4"x9"

Sleeved Model 481-6058

Individually Boxed 712-6314

9" Deep Single Bowl

18 Gauge



29-7/8"x18-1/16"x9"

Sleeved Model 481-1422

Individually Boxed 712-6316

9" Deep Single Bowl

18 Gauge



Prestige Top-Mount Sinks

25"x22"x8-1/2"

Sleeved Model 482-6834

Individually Boxed 712-6837

8-1/2" Deep Single Bowl

20 Gauge / 1 Hole

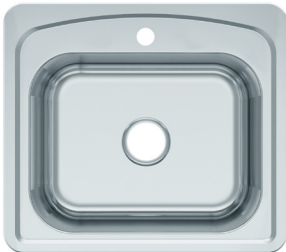

33"x22"x8-1/2"

Sleeved Model 482-6835

Individually Boxed 712-6838

8-1/2" Deep Large Single Bowl

20 Gauge / 1 Hole

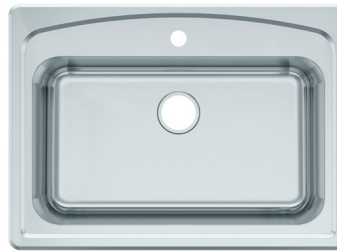

33"x22"x8-1/2"

Sleeved Model 482-6836

Individually Boxed 712-6839

8-1/2" Deep 50/50 Bowl

20 Gauge / 1 Hole

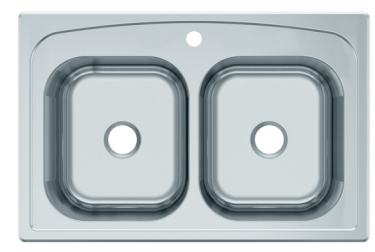

This series can be purchased with 1, 2 or 3 hole faucet configurations. Ask your sales representative for more information!

www.cmiproduct.com

ADA Top-Mount Sinks

25"x22"x5-1/2"

Sleeved Model 482-6509
Individually Boxed 712-6755

5-1/2" Deep Single Bowl
18 Gauge / 3 Hole

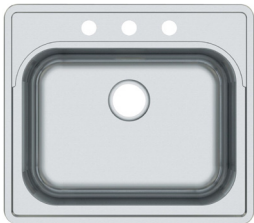

33"x19"x5-1/2"

Sleeved Model 482-6508
Individually Boxed 712-6756

5-1/2" Deep 50/50 Bowl
18 Gauge / 3 Hole



33"x22"x5-1/2"

Sleeved Model 482-6507
Individually Boxed 712-6757

5-1/2" Deep 50/50 Bowl
18 Gauge / 3 Hole



33"x22"x5-1/2"

Sleeved Model 482-7544
Individually Boxed 712-7961

5-1/2" Deep Large Single Bowl
18 Gauge / 1 Hole



33"x22"x5-1/2"

Sleeved Model 482-7545
Individually Boxed 712-7962

5-1/2" Deep Large Single Bowl
18 Gauge / 3 Hole



30"x18"x5-1/2"

Under-Mount Sink

Sleeved Model 482-6959
Individually Boxed 712-7963

5-1/2" Deep Large Single Bowl
18 Gauge



23"x18"x5-1/2"

Under-Mount Sink

Sleeved Model: 482-8143
Individually Boxed: 712-8147

5-1/2" Deep Single Bowl
18 Gauge

Single Bowl Top-Mount Sinks



15"x15"x6"

Sleeved Model 004-136
Individually Boxed 712-6296

6" Deep Single Bowl
22 Gauge / 2 Hole

15"x15"x8"

Sleeved Model 481-5477
Individually Boxed 712-6297

8" Deep Single Bowl
22 Gauge / 2 Hole



19"x17"x8"

Sleeved Model 482-6121
Individually Boxed 712-6298

8" Deep Large Single Bowl
20 Gauge / 2 Hole

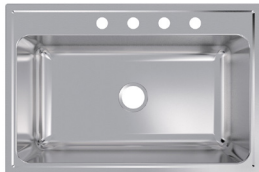

33"x22"x9"

Individually Boxed 482-7829

9" Deep Single Bowl
18 Gauge / 4 Hole



25"x22"x8"

Sleeved Model 481-2967
Individually Boxed 712-6299

8" Deep Single Bowl
22 Gauge / 3 Hole



25"x22"x6"

Sleeved Model 003-525
Individually Boxed 712-6300

6" Deep Single Bowl
23 Gauge / 4 Hole

25"x22"x8"

Sleeved Model 481-5441
Individually Boxed 712-6301

8" Deep Single Bowl
22 Gauge / 4 Hole

25"x22"x10"

Sleeved Model 481-6936
Individually Boxed 712-6302

10" Deep Single Bowl
20 Gauge / 4 Hole

Double Bowl Top-Mount Sinks



33"x19"x6"
Sleeved Model 004-632
Individually Boxed 712-6303
6" Deep 50/50 Bowl
23 Gauge / 4 Hole

33"x19"x7"
Sleeved Model 006-052
Individually Boxed 712-6304
7" Deep 50/50 Bowl
22 Gauge / 4 Hole

33"x19"x8"
Sleeved Model 006-780
Individually Boxed 712-6305
8" Deep 50/50 Bowl
22 Gauge / 4 Hole

33"x22"x6"
Sleeved Model 481-1338
Individually Boxed 712-6306
6" Deep 50/50 Bowl
23 Gauge / 3 Hole

33"x22"x7"
Sleeved Model 482-6122
Individually Boxed 712-6307
7" Deep 50/50 Bowl
22 Gauge / 3 Hole

33"x22"x8"
Sleeved Model 481-0531
Individually Boxed 712-6308
8" Deep 50/50 Bowl
20 Gauge / 3 Hole



33"x22"x6"
Sleeved Model 003-513
Individually Boxed 712-6309
6" Deep 50/50 Bowl
23 Gauge / 4 Hole

33"x22"x7"
Sleeved Model 481-5475
Individually Boxed 712-6310
7" Deep 50/50 Bowl
22 Gauge / 4 Hole

33"x22"x8"
Sleeved Model 481-5476
Individually Boxed 712-6311
8" Deep 50/50 Bowl
20 Gauge / 4 Hole

Grab-N-Go Stainless Steel Sink Kits



712-6027

- 1- 25" x 22" x 8" Single Bowl Stainless Steel Sink
- 1- Two Handle High-Arc Kitchen Faucet with Side Spray
- 1- Chrome Finish Stainless Steel Basket Strainer



712-6263

- 1- 15" x 15" x 6" Single Bowl Bar Stainless Steel Sink
- 1- Two Handle Bar Faucet
- 1- Chrome Finish Stainless Steel Basket Strainer



712-6025

- 1- 33" x 22" x 7" 50/50 Double Bowl Stainless Steel Sink
- 1- Single Handle Kitchen Faucet with Side Spray
- 2- Chrome Finish Stainless Steel Basket Strainers



712-6026

- 1- 33" x 22" x 8" 50/50 Double Bowl Stainless Steel Sink
- 1- Single Handle High-Arc Pull-Down Kitchen Faucet
- 1- Brushed Nickel Soap Dispenser
- 2- Brushed Nickel Finish Stainless Steel Basket Strainers

Ruston

Granite Composite Work Station Sinks



33"x22"x9"
Ruston Sink
Model 132-6983
Dual-Mount - Sand
1 Hole
9" Depth
Large Single Bowl



33"x22"x9"
Ruston Sink
Model 132-7289
Dual-Mount - Brown
1 Hole
9" Depth
Large Single Bowl



33"x22"x9"
Ruston Sink
Model 132-7288
Dual-Mount - Grey
1 Hole
9" Depth
Large Single Bowl



33"x22"x9"
Ruston Sink
Model 132-6984
Dual-Mount - Black
1 Hole
9" Depth
Large Single Bowl



33"x22"x9"
Ruston Sink
Model 132-7381
Dual-Mount - White
1 Hole
9" Depth
Large Single Bowl

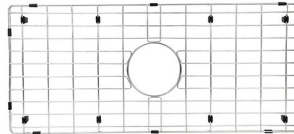
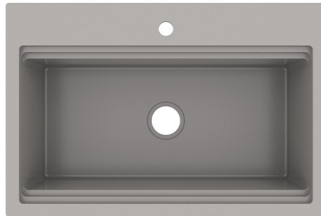

Includes: Corrosion Resistant Grid(s), Wood Cutting Board, Stainless Steel Colander & Drying Rack. Not Included: Faucet or Basket Strainer(s).

This series has knockouts for 2, 3 or 4 hole faucet configurations. Hole saw included.



 COMPASS®
MANUFACTURING
INTERNATIONAL

CMI FAMILY OF PRODUCTS



Compass Manufacturing International
P. 800.626.3525

info@cmiproduct.com

Browse all of our Products: www.cmiproduct.com